



USER MANUAL

INSTALLATION & OPERATION

Aquarium Chiller

Applicable Models: TK 5K

TK 8K

TK 15K

TECO S.r.l.
Via A. Sansovino, 35 48124 Ravenna - ITALY
Tel.: +39 0544 408333 - Fax: +39 0544 280084
www.tecoonline.com





THIS MANUAL MUST BE READ AND UNDERSTOOD BY A QUALIFIED PERSON OR PERSONS BEFORE INSTALLATION

CONTENT

Introduction of Aquarium Chiller	1
Install And Safety Precautions	1
Transportation and Storage	2
Technical Specifications	2
Dimensions	4
Rules for the installation	5
Electric Circuit Drawing	6
Controller	8
STATEMENT	11



Energy, let's save it!!!

Introduction

- 1) Chiller in this manual are designed for heating and cooling water within 5°C to 40°C.
- 2) It is suitable for fresh water and salt water at the ambient temperature from 5°C to 35°C.

Safety Precautions

Attention!

THIS PRODUCT IS NOT SUITABLE FOR CHILDREN BELOW SIX YEARS.

Children should be supervised to ensure that they do not play with the appliance. This appliance is not intended for use by person (including children) with reduced physical, sensory or mental capabilities, or lack of experience and knowledge, unless they have been given supervision or instruction concerning use of the appliance by a person responsible for their safety.

NOTE : KEEP THESE INSTRUCTIONS FOR FUTURE REFERENCES.

NOTE : KEEP THE PACKING FOR FUTURE TRANSPORTS.

General

- 1) Before install the chiller, please confirm the local power supply is in accordance with the requirement of the chiller, refer to the Technical data and the Wiring diagram provided in the manual.
- 2) Connecting the chiller to a ground wire is necessary, in order to prevent electrical shock caused by an unexpected short circuit inside the unit.
- 3) Please install the electrical protection devices, according to the local regulations.
- 4) The chiller must be installed on reliable base or supporting framework.
- 5) If the chiller is installed on the floor, its base or supporting framework should be heightened, to avoid ingress of accumulated water in rainy season. In snowy areas, it is important to prevent accumulated snow from blocking up the air-out. The recommended height is 20cm to 30cm.
- 6) Install the drainage pipe before fix the chiller to the ground. There are two drainage hole on the chiller base, which could be connected to the drainage pipe with a pipe arches which contains in spare parts.
- 7) Drain ditch or other facilities should be arranged under the chiller, to avoid the environment influence because of water discharge.
- 8) Ensure the unit is well ventilated, direction of air exhaust is kept away from windows of neighboring buildings, and the exhaust air cannot flow back. Moreover, adequate service clearance should be kept around the unit.
- 9) DO NOT put fingers or sticks into the ventilative fan.
- 10) The unit should not be installed at places accompanied with oil, inflammable gas, corrosive components e.g. sulfur compound, or high-frequency equipment.
- 11) The chiller is usually placed next to a house, which gives a directed sound distribution that should be considered, so it should take proper action to reduce the noise impact.

- 12) Cut off the power supply before maintaining the unit, and the maintenance work should be carried out by professional.
- 13) If any abnormality occurs in the Chiller, such as abnormal noise or burned smell, cut off the power supply immediately, and contact professionals for check and repair.
- 14) Clean the Chiller with follow instructions:
- ▶ Before cleaning, cut off the power supply firstly to avoid any potential danger.
 - ▶ Don't rinse the unit by water because it may lead to electric shock.

Transportation and Storage

- 1) The Chiller **MUST** be transported and stored **VERTICALLY!**
- 2) The Chiller **MUST** be transported and stored uprightly on a pallet with good package.
- 3) Should the Chiller be laid down, please wait at least 12 hours before switching it on.

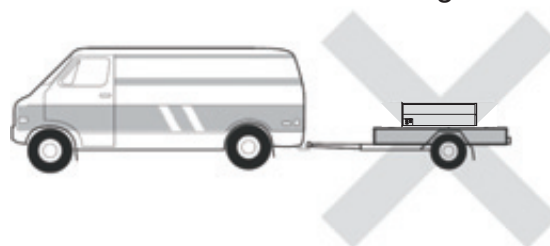
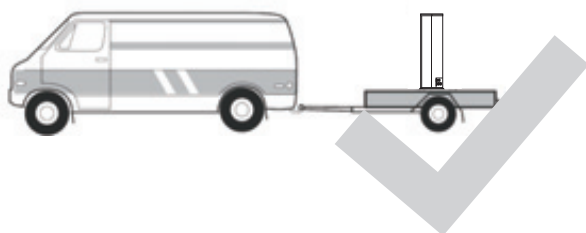

Technical Specifications

Model Number		TK 5K	TK 8K	TK 15K	
Summer Condition [1]	Cooling Capacity	W	5800	8700	14600
	Cooling Input	W	2030	4350	6890
	Normal Current	A	9.3	7.6	11.5
	COP		2.86	2.1	2.1
Winter Condition [2]	Heating Capacity	W	4500	9400	15200
	Heating Input	W	1500	2800	4100
	Normal Current	A	7	5.4	7.3
	COP		3	3.4	3.7
Max. Current	A	39	52	72	
Power Supply	V / Ph / Hz	220-240V / 1PH / 50Hz	380-415V / 3PH / 50Hz	380-415V / 3PH / 50Hz	
Setting Temp. Range	°C	5 °C - 40 °C			
Running Temp. Range	°C	5 °C - 35 °C			
Water Heat Exchanger		Titanium PVC Tank			
Compressor		Rotary	Scroll	Scroll	
Water Inlet/Outlet Dimension		1,5 "			
Nominal Water Flow	l / h	3000	4500	6500	
Sound Pressure Level at 1m/4m/10m [3]	dB(A)	51 / 38 / 30	52 / 40 / 32	55 / 42 / 32	
Unit Dimensiond (L*W*H)	mm	816*690*835	816*690*850	816*690*1050	
Packing Dimensiond (L*W*H)	mm	920*800*1010	920*800*1010	920*800*1210	
Net Weight	kg	100	135	155	
Gross Weight	kg	114	151	173	
Refrigerant		R410A			
Display		LED			
Mode		Heating / Cooling / Auto			
[1] Ambient air temperature 38°C, inlet water temperature 25°C					
[2] Ambient air temperature 5°C, inlet water temperature 25°C					
[3] Noise from 1 m, 4 m or 10 m (in DBA) (As in the directive EN ISO 3741 & EN ISO 354)					

Model Number		TK 5K	TK 8K	TK 15K	
Summer Condition [1]	Cooling Capacity	W	5700	10000	15100
	Cooling Input	W	2080	4490	6900
	Normal Current	A	9.2	19.8	20.8
	COP		2.76	2.24	2.17
Winter Condition [2]	Heating Capacity	W	5900	9400	15300
	Heating Input	W	1530	2900	4280
	Normal Current	A	6.7	13.1	15.2
	COP		3.86	3.24	3.57
Max. Current		A	39	120	130
Power Supply		V / Ph / Hz	208-230V / 1PH / 60Hz	208-230V / 1PH / 60Hz	208-230V / 3PH / 60Hz
Setting Temp. Range		°C	5 °C - 40 °C		
Running Temp. Range		°C	5 °C - 35 °C		
Water Heat Exchanger			Titanium PVC Tank		
Compressor			Rotary	Scroll	Scroll
Water Inlet/Outlet Dimension			1,5 "		
Nominal Water Flow		l / h	3000	4500	6500
Sound Pressure Level at 1m/4m/10m [3]		dB(A)	51 / 38 / 30	52 / 40 / 32	55 / 42 / 32
Unit Dimensiond (L*W*H)		mm	816*690*835	816*690*850	816*690*1050
Packing Dimensiond (L*W*H)		mm	920*800*1010	920*800*1010	920*800*1210
Net Weight		kg	100	135	155
Gross Weight		kg	114	151	173
Refrigerant			R410A		
Display			LED		
Mode			Heating / Cooling / Auto		
[1] Ambient air temperature 38°C, inlet water temperature 25°C					
[2] Ambient air temperature 5°C, inlet water temperature 25°C					
[3] Noise from 1 m, 4 m or 10 m (in DBA) (As in the directive EN ISO 3741 & EN ISO 354					

Dimensions

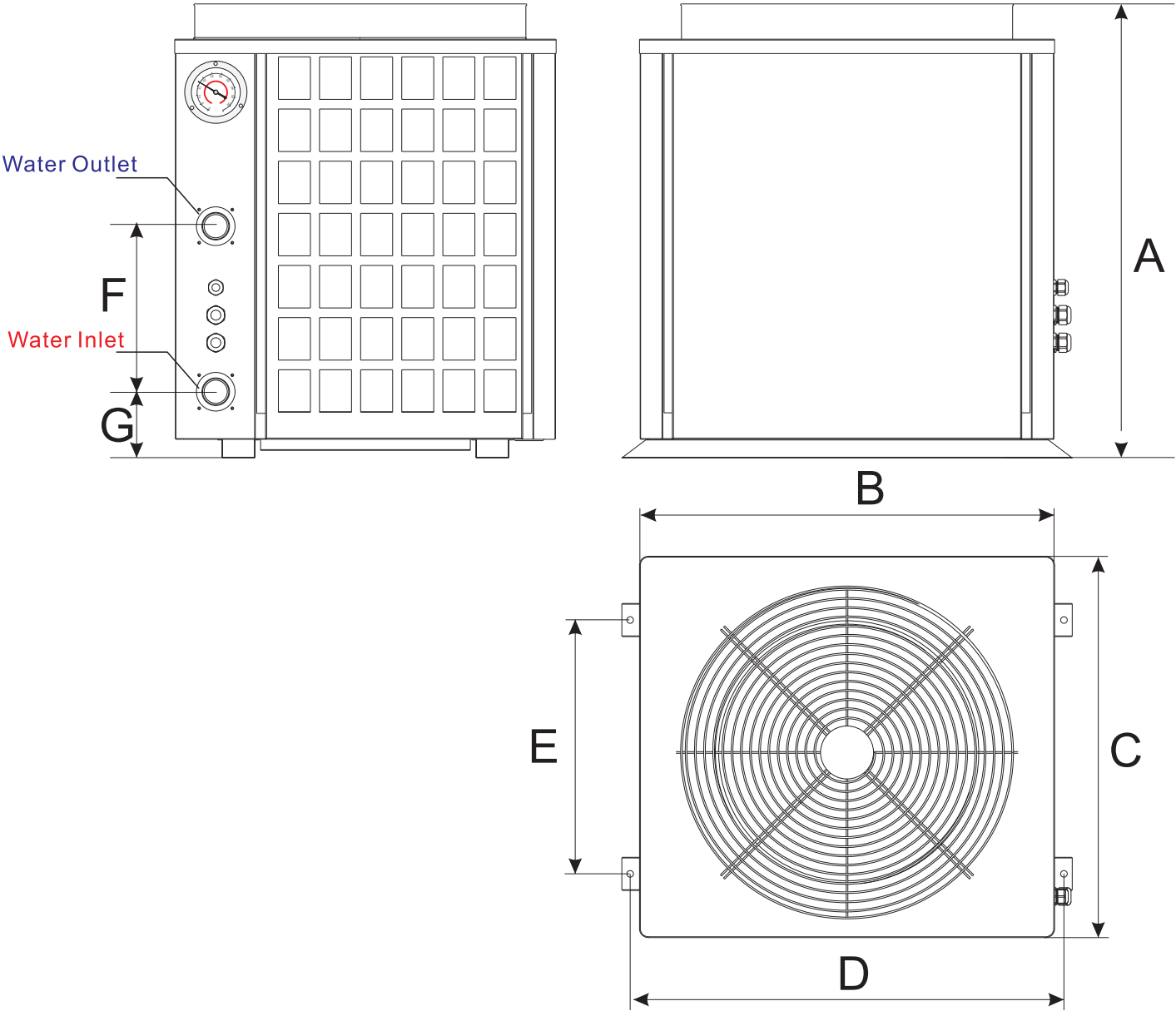

NO.	TK 5K	TK 8K	TK 15K
A	827mm	842mm	1042mm
B	725mm	725mm	725mm
C	665mm	665mm	665mm
D	765mm	765mm	765mm
E	460mm	460mm	460mm
F	300mm	300mm	500mm
G	116mm	116mm	116mm

Rules for the installation

ATTENTION

 To grant the right functioning of the unit in safe conditions, it is absolutely forbidden its exposition at atmospheric conditions and direct sources of heat. The maximum ambient temperature allowed is 35°C.

ATTENTION

 The place in which the unit will be installed must have the following characteristics:
See image.

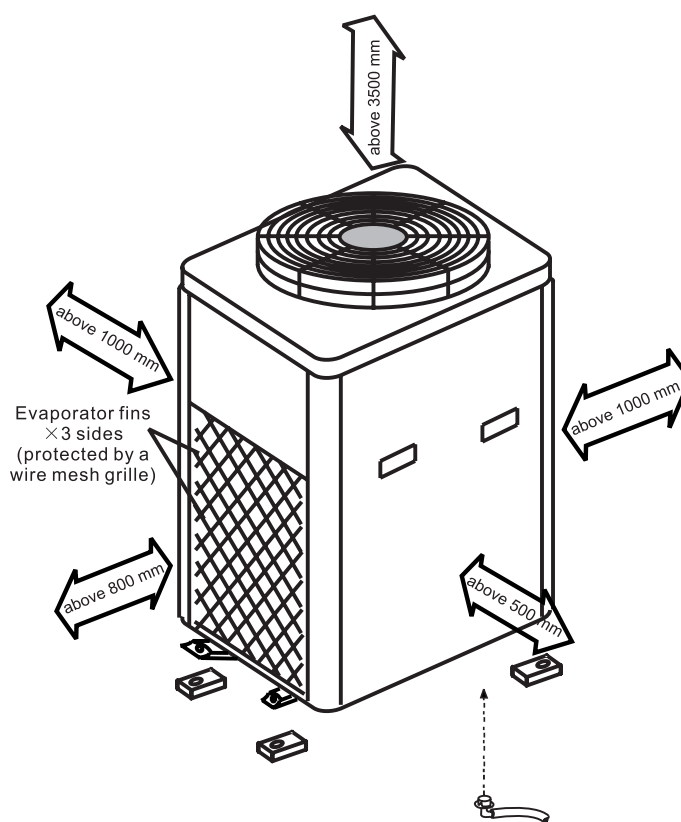

Make sure that easy access can be gained to service panel and plumbing connection. Do not block access to the control panel or electrical outlets. Make sure the grilles are not blocked or obstructed.

Multiple connection-install chiller 500mm apart and independently 20A circuit breaker protection.

Electric Circuit Drawing

Model: TK 5K(220~240V/50Hz/1PH)

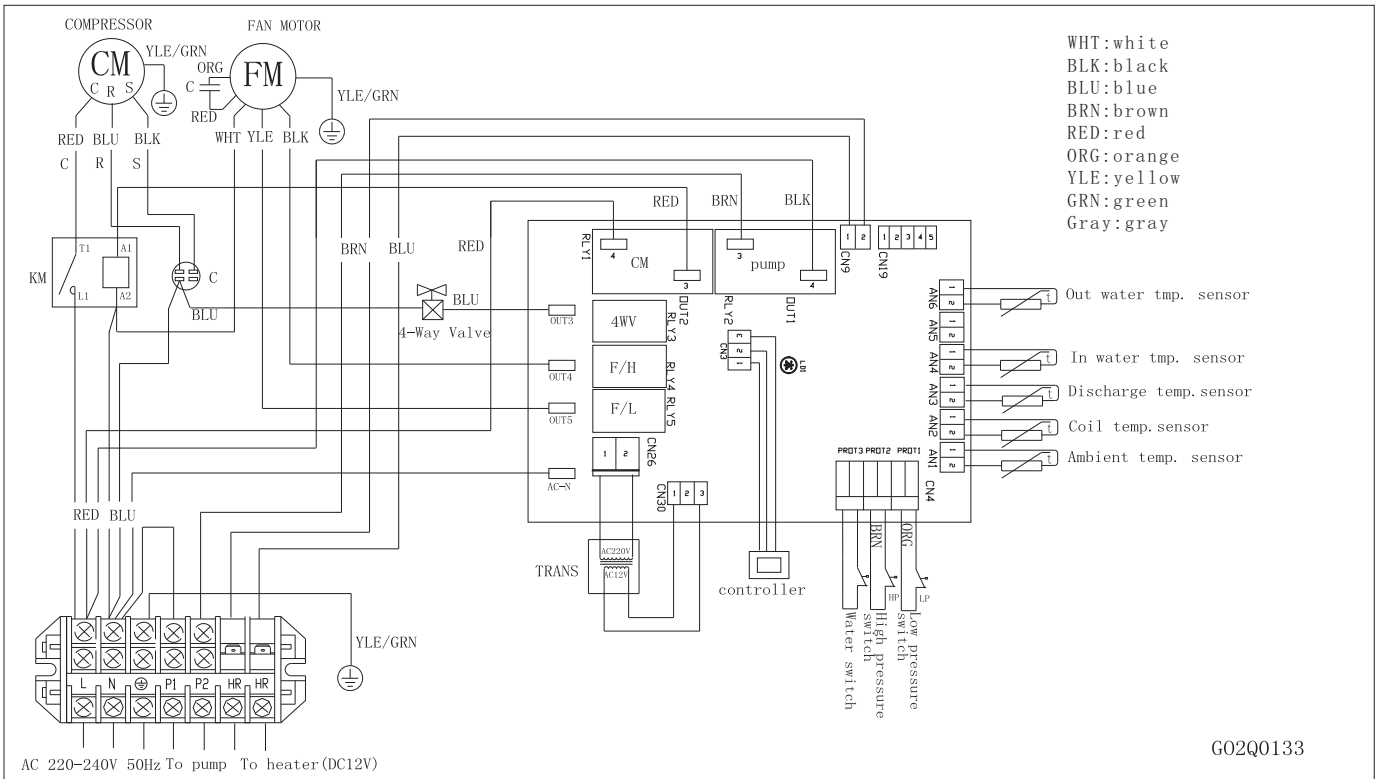

Model: TK 8K\TK 15K(380~415V/50Hz/3PH)

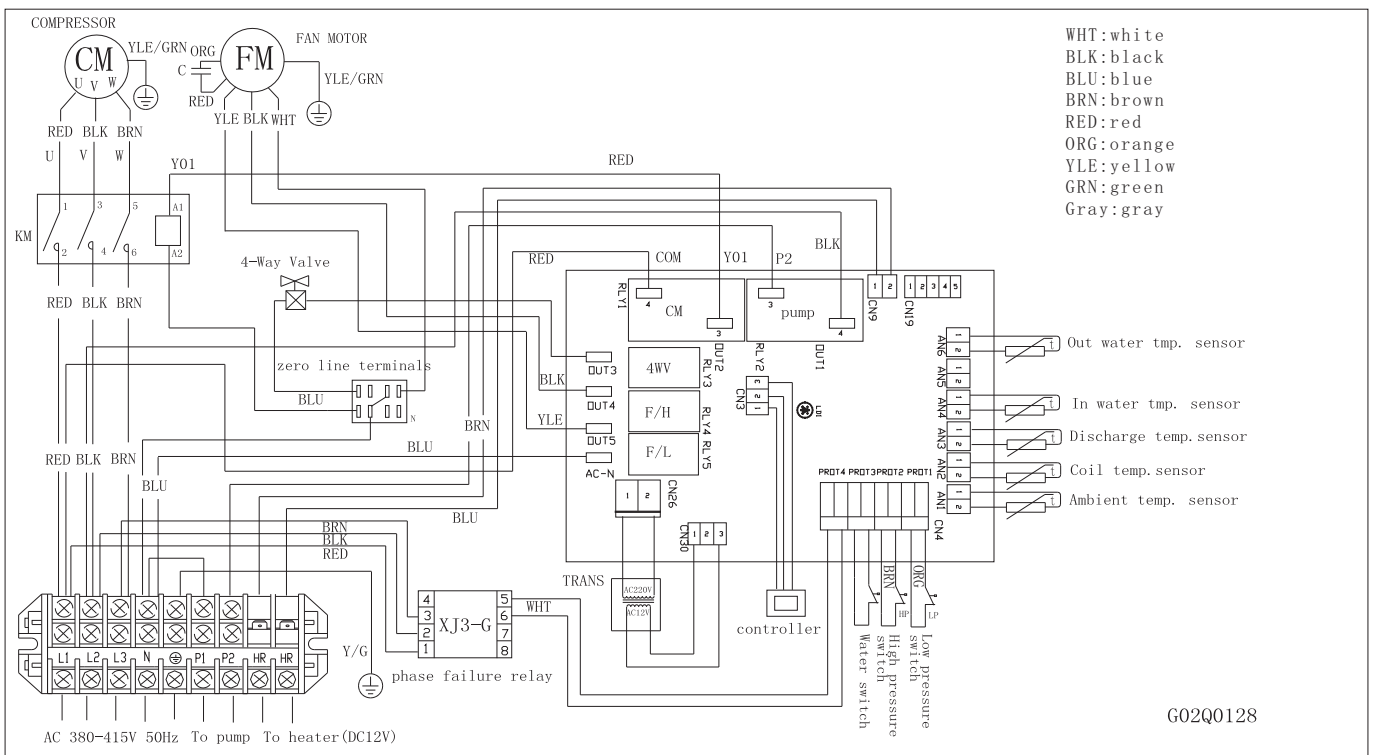

Electric Circuit Drawing

Model: TK 5K\TK 8K(208~230V/60Hz/1PH)

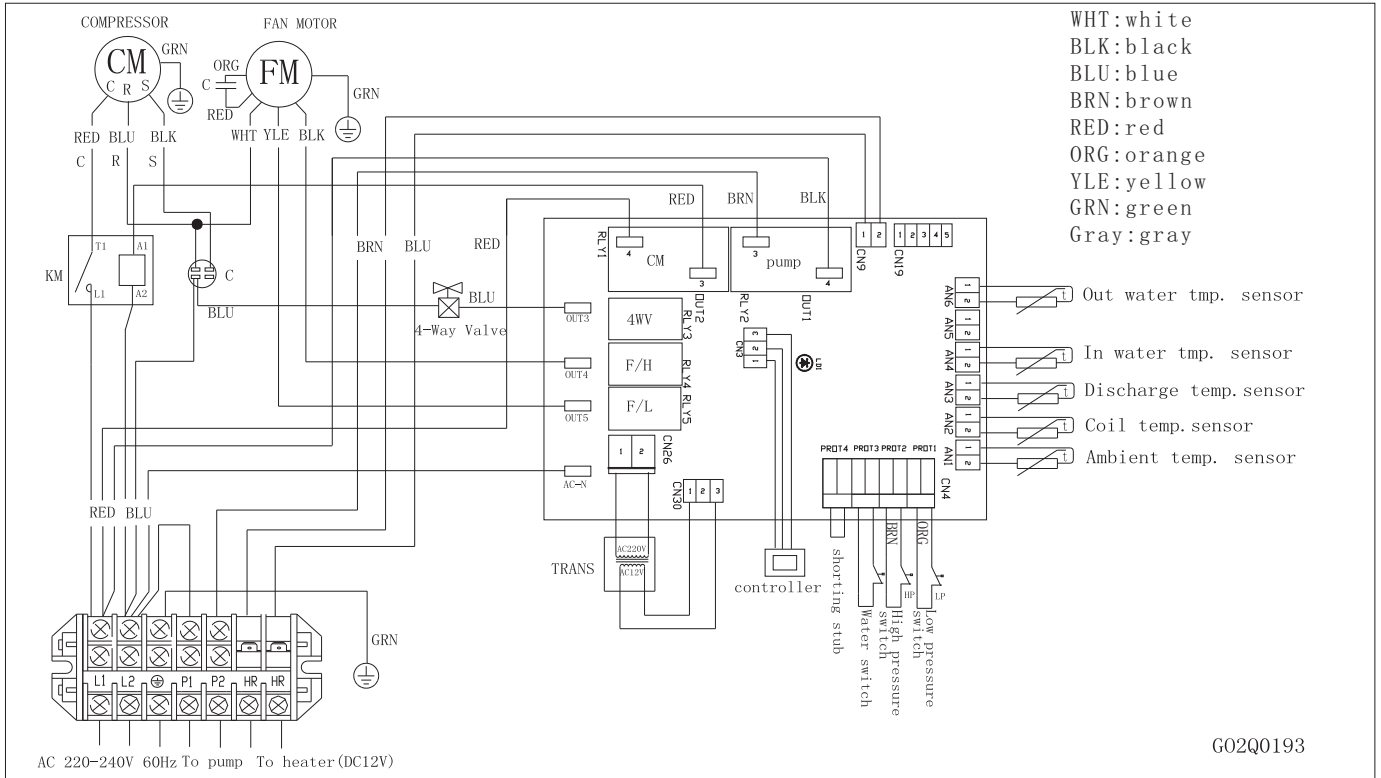

Model: TK 15K(208~230V/60Hz/3PH)

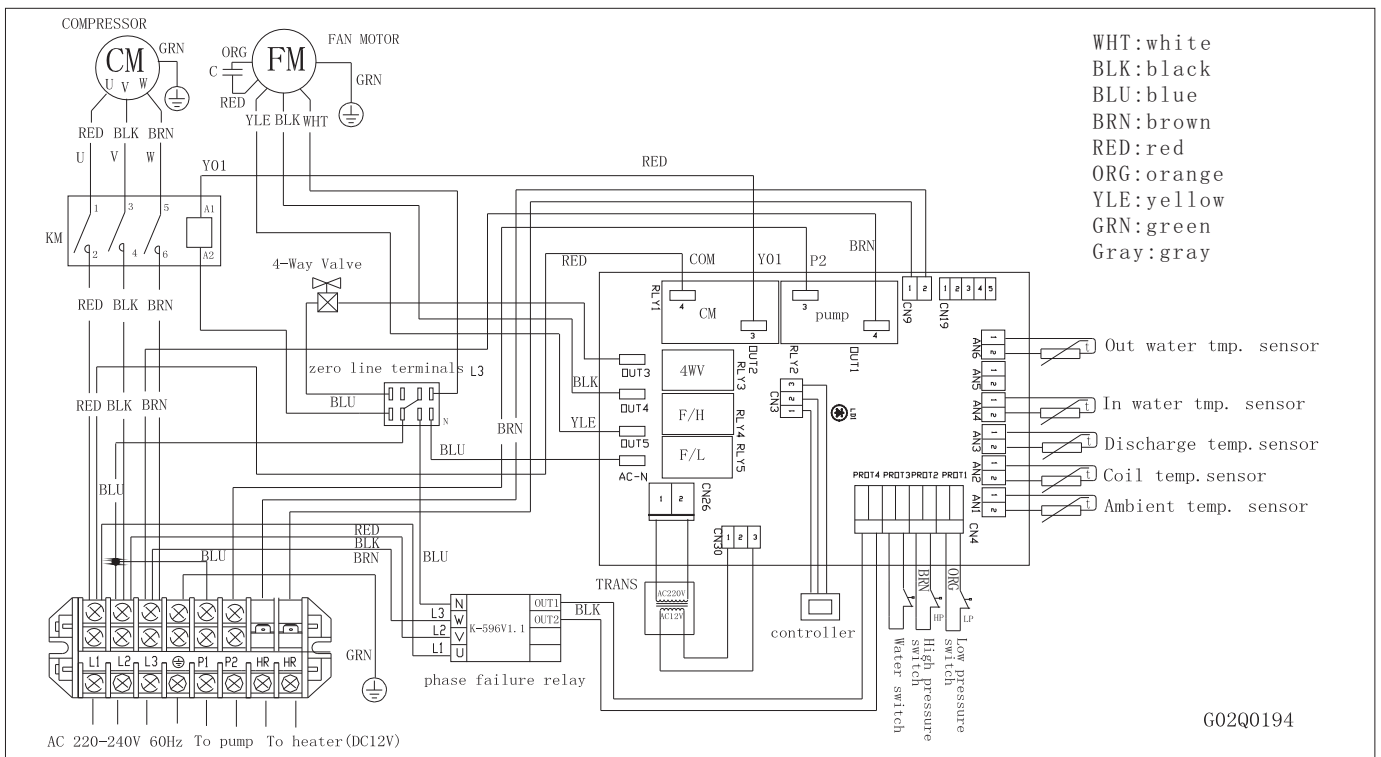

Controller Regulation (digital controller)

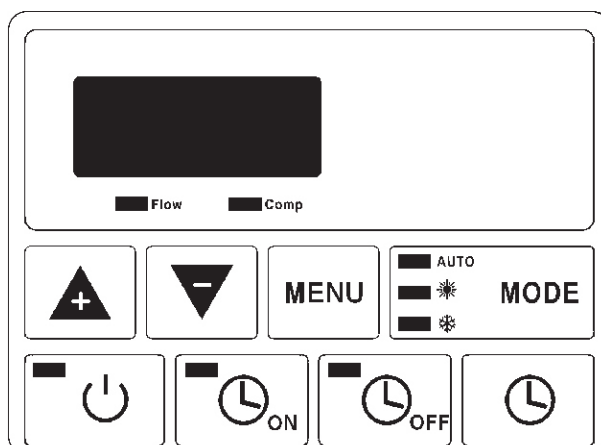



ON / OFF

Button  starts or stops the machine. (Attention! When the machine is being turned ON or OFF, it may take up to a few minutes to activate or deactivate.)



Working modes

Button  is to choose the Chiller working mode.



To choose the working mode, press this button till the corresponding LED on the display is lighting up.

- Auto : Automatic heating and cooling mode.
Maintains the temperature of the water between heating temperature setting and cooling temperature setting (+ or -2°C).
-  : Water heating mode.
Maintains the water temperature at the heating temperature setting (+ or -2°C).
-  : Water cooling mode
Maintains the water temperature at the cooling temperature setting (+ or -2°C).



Water heating setting

- Turn the machine into heating mode (see 《working modes》).
- Press , number 《1》 is shown followed by the heating setting value.
- Set the value with  and . It saves automatically after a few seconds.

Water cooling setting







- Turn the machine into cooling mode (see 《working modes》).
- Press , number 《1》 is shown followed by the cooling setting value.
- Set the value with  and . It saves automatically after a few seconds.

Keyboard lock

It is possible to lock / unlock the keyboard by pressing  and  in the same time during a few seconds, the display makes a "bip" sound when it is locked / unlocked.











Clock setting

To set the clock time:











- Press  one time (time is blinking).
- Press  a second time (hours are blinking), set the hours with  and .
- Press  a third time (minutes are blinking), set the minutes with  and .

Timer ON/OFF setting

Timer ON setting

- Press  one time (time is blinking).
- Press  a second time (hours are blinking), set the hours with  and .
- Press  a third time (minutes are blinking), set the minutes with  and .
- When the setting is done, the LED from button  lights up.
- To cancel the setting, press  one time and  one time (the LED from button  will stop lighting).

Timer OFF setting

- Press  one time (time is blinking).
- Press  a second time (hours are blinking), set the hours with  and .
- Press  a third time (minutes are blinking), set the minutes with  and .
- When the setting is done, LED from button  lights up.
- To cancel the setting, press  one time and  one time (the LED from button  will stop lighting).

Others parameters

Button  helps to check internal parameters (cannot be set).

Controller state table

Screen	Explanation	Check	Solution (if no reset)
OFF	Stand-by	-	-
<<Flow >>not lighting FLO EE3	No water flow or the flow switch doesn't detect the water flow	- Check if filtration pump is working. - Check by-pass setting. - Check water flow switch setting.	(Contact your seller)
EE6	Comp. Out temp. Too high	- Check if filtration pump is working. - Check by-pass setting.	
EE7	Memory problem	Change PCB	
EE8	Communication error.	Check electrical connection between controller and electronic card inside the machine.	
PP1	Probe error (Water in)	Check probe connection.	
PP3	Probe error (evap.)		
PP4	Probe error (comp. in)		
PP5	Probe error (ambiance)		
PP6	Too much difference between water in and water out.	Check by-pass setting.	
PP7	Defrost protection.	Ambient temperature was lower than the minimum working range temperature.	
HP PP9	High pressure protection	- Check by-pass setting. - Check water flow switch setting.	
LP PP9	Low pressure protection	- Check if there is gas inside the machine (manometer between 0,5 and 1 when machine is stopped). - Ambient temperature was lower than the minimum working range temperature.	

Notice

1. Maximum and minimum working pressure : 7Bar/1Bar
2. Model code and rated value of current fuse: 5AL250, ϕ 5X20. RATED CURRENT 5a , RATED VOLTAGE 250v
3. The diameter and model of power wire should be H07RN-F:3 X 4mm²
4. The means for disconnection must be incorporated in the fixed wiring and have an air gap contact separation of at least 3mm in each active(phase)conductors.
5. If the supply cord is damaged, it must be replaced by the manufacturer or its service agent or a similarly qualified person in order to avoid a hazard.
6. This appliance can be used by children aged from 8 years and above and persons with reduced physical, sensory or mental capabilities or lack of experience and knowledge if they have been given supervision or instruction concerning use of the appliance in a safe way and understand the hazards involved.
7. Children shall not play with the appliance. Cleaning and user maintenance shall not be made by children without supervision.
8. The appliance shall be installed in accordance with national wiring regulations.

STATEMENT OF CONFORMITY TO EEC STANDARDS

WE:

TECO S.r.l. - TECNOLOGIE DI REFRIGERAZIONE

Sede Legale, Amministrativa e Commerciale: Via A. Sansovino, 35 - 48124 RAVENNA - C. F. / P. IVA 01075610392

HEREWITH DECLARE UNDER OUR RESPONSIBILITY THAT OUR PRODUCTS: MODD.: TC500, TC800, Tc1500
TO WHICH THIS STATEMENT REFERS, ARE MANUFACTURED IN ACCORDANCE WITH THE FOLLOWING REGULATIONS

2004/108/CE ELECTROMAGNETIC COMPATIBILITY DIRECTIVE

2006/95/CE LOW VOLTAGE SAFETY DIRECTIVETHE

FOLLOWING TECHNICAL STANDARDS AND SPECIFICATIONS HAVE BEEN OBSERVED:

Safety

Regulations used: EN 60335 - 1 / EN 60335 - 2 - 55 AND RELATED AMENDMENTS

EMC directive

Regulations used: EN 61000 - 6 - 1 / EN 61000 - 6 - 3 AND RELATED AMENDMENTS

Turci Bruno
Manager



RAVENNA 21 01 2010



WARRANTY CONDITIONS

The units manufactured by TECO S.r.l. are on WARRANTY, according to the laws of the country in which are commercialised.

If during warranty period, it should arise defective working or damages of the unit, which will be part of the cases indicated in the warranty, TECO S.r.l. , after the proper inspections on the unit, will provide at the reparation or replacement of the defective parts.

The warranty is valid only if the document (invoice, ticket or equivalent), which will assure the date of purchasing of the unit, will be presented to a retailer or an authorized TECO assistance centre.

ATTENTION

Please remember that eventual changes done by the end user, without explicit written TECO S.r.l. authorisation, will invalid the warranty and TECO S.r.l. will not be responsible of damages caused by the defective unit. The same conditions are valid also in case of use of not originally spare parts or different from the ones explicitly indicated by TECO S.r.l..

Note:

Specifications in this user manual are subject to change without prior notice that we may bring the latest innovations to their customers.

Whilst every effort is made to ensure that all specifications are correct, printing errors are beyond our control; we can not be held responsible for these errors.
